

60 mm

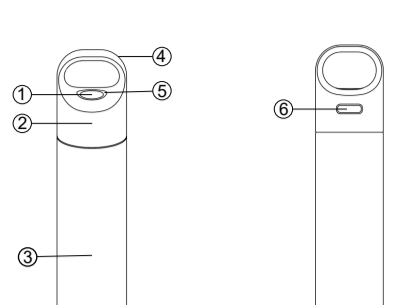

ENGLISH
IN THE BOX
1x Collapsible case
1x Cleaning brush
1x USB-C charging cable

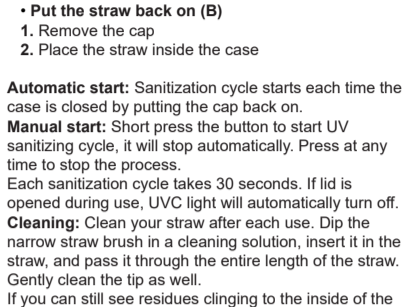

LED STATUS table with columns for Sanitization on-going, Charging, Fully charged, and Battery low.

PRODUCT SPECIFICATIONS
Case dimensions: 00.94 x 5.08" / 02.4 x 12.9 cm
Folded straw: 3.54" / 9 cm
Unfolded straw: 8.27" / 21 cm

SAFETY PRECAUTIONS
Do not put into dishwasher or microwave
Do not use bleach or abrasive cleaners containing chlorine
Do not put water in the straw case or any other liquid

FRANÇAIS
DANS LA BOÎTE
1x Pack rétractable
1x Brosse de nettoyage
1x câble de charge USB-C

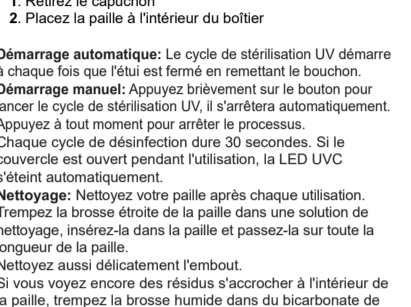

LED STATUS table with columns for Sanitization on-going, Charging, Fully charged, and Battery low.

SPÉCIFICATIONS TECHNIQUES
Dimensions du boîtier: 02.4 x 12.9 cm
Paille pliée: 9 cm
Paille dépliée: 21 cm

PRÉCAUTIONS DE SÉCURITÉ
Ne pas utiliser d'eau de javel ou de nettoyants abrasifs
Ne pas mettre d'eau dans le boîtier ou tout autre liquide
N'utilisez pas de produits abrasifs

DEUTSCH
LIEFERUMFANG
1x Pack zusammenklappbar
1x Reinigungsbürste
1x Bedienungsanleitung

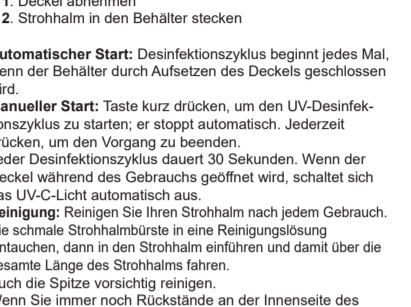

LED STATUS table with columns for Sanitization on-going, Charging, Fully charged, and Battery low.

PRODUKTSPECIFIKATIONEN
Abmessungen Gehäuse: 00.94 x 5.08" / 02.4 x 12.9 cm
Geöffnetes Produkt: 0.11 / 9 cm
Geschlossenes Produkt: 8.27" / 21 cm

SICHERHEITSHINWEISE
Nicht in die Spülmaschine oder Mikrowelle geben
Keine Bleichmittel oder ähnlichen Scharfmittel verwenden
Nicht in Wasser oder anderen Flüssigkeiten tauchen

NEDERLANDS
IN DE DOOS
1x Pakket inkl. opvouwbare riet
1x reinigingsborstel
1x gebruikershandleiding



LED STATUS table with columns for Sanitization on-going, Charging, Fully charged, and Battery low.

PRODUCTSPECIFICATIES
Afmetingen doos: 00.94 x 5.08" / 02.4 x 12.9 cm
Open product: 0.11 / 9 cm
Gesloten product: 8.27" / 21 cm

VEILIGHEIDSAANBEVELINGEN
Niet in de vaatwasser of magnetron doen
Gebruik geen afbleekmiddelen
Gebruik geen afwasmiddel

ITALIANO
CONTENUTO DELLA CONFEZIONE
1x Busta ripiegabile e riutilizzabile
1x Custodia igienizzante
1x Manuale d'uso

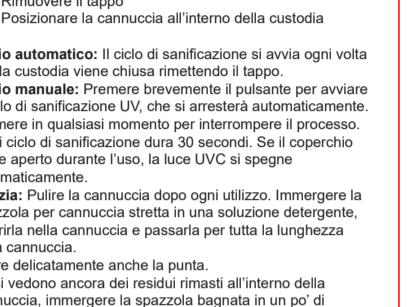

LED STATUS table with columns for Sanitization on-going, Charging, Fully charged, and Battery low.

SPECIFICHE DEL PRODOTTO
Dimensioni della custodia: 00.94 x 5.08" / 02.4 x 12.9 cm
Paglia ripiegata: 3.54" / 9 cm
Paglia srotolata: 8.27" / 21 cm

PRECAUZIONI DI SICUREZZA
Non mettere in lavastoviglie o in microonde
Non utilizzare candeggina o detersivi abrasivi contenenti cloro
Non usare acqua nella custodia della cannucina

ESPAÑOL
CONTENIDO DE LA CAJA
1. Bolsa (UV-riutilizable)
1. Caja de higienización
1. Manual de usuario

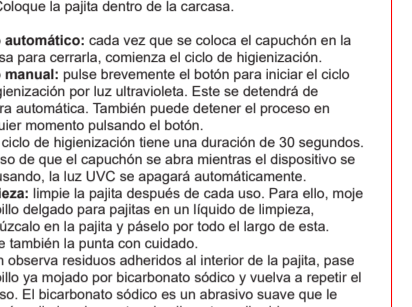

LED STATUS table with columns for Sanitization on-going, Charging, Fully charged, and Battery low.

ESPECIFICACIONES DEL PRODUCTO
Dimensiones de la carcasa: 00.94 x 5.08" / 02.4 x 12.9 cm
Pajilla plegada: 3.54" / 9 cm
Pajilla desplegada: 8.27" / 21 cm

PRECAUCIONES DE SEGURIDAD
No coloque el dispositivo en el lavavajillas ni en el horno microondas
No utilice agua ni ningún otro líquido en la carcasa de la pajilla
No utilice lejía ni otros productos de limpieza abrasivos

PORTUGUÊS
INCLUIDO NA CAIXA
1. Bolsa (UV-reutilizável)
1. Caixa de higienização
1. Manual do utilizador

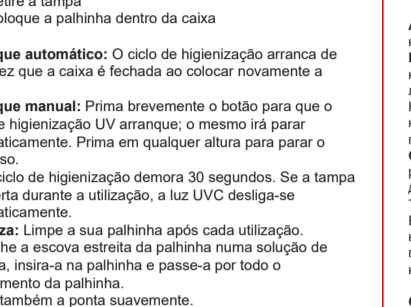

LED STATUS table with columns for Sanitization on-going, Charging, Fully charged, and Battery low.

ESPECIFICAÇÕES DO PRODUTO
Dimensões da caixa: 00.94 x 5.08" / 02.4 x 12.9 cm
Pajinha dobrada: 3.54"/9 cm
Pajinha desdobrada: 8.27"/21 cm

PRECAUÇÕES DE SEGURANÇA
Não coloque a máquina de lavar louça ou micro-ondas
Não utilize água nem qualquer outro líquido na caixa da pajinha
Não utilize produtos de limpeza abrasivos

РУССКИЙ
КОМПЛЕКТ
1x Упаковка многоразового соломинки
1x Дезинфицирующий футляр
1x Инструкция по эксплуатации

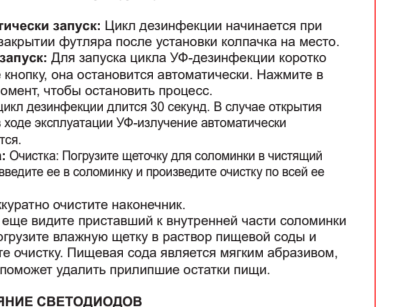

LED STATUS table with columns for Sanitization on-going, Charging, Fully charged, and Battery low.

ХАРАКТЕРИСТИКИ ИЗДЕЛИЯ
Размеры футляра: 00.94 x 5.08" / 02.4 x 12.9 см
Сложенная соломинка: 3.54" / 9 см
Раскрытая соломинка: 8.27" / 21 см

МЕРЫ ПРЕДОСТОРОЖИЯ
Не класть в посудомоечную машину или микроволновку
Не использовать хлорсодержащие отбеливатели или абразивные чистящие средства
Не допускать попадания воды или иных жидкостей

日本語
内容物
1x 折りたたみ可能な収納ケース
1x 充電ケーブル
1x USB-C充電ケーブル

製品概要
1. 収納ケース (UV-リムーブ)
2. ケース (充電ケーブル)
3. 本体
4. 充電ケーブル
5. USB-C充電ケーブル

仕様と寸法
ケース寸法: 00.94 x 5.08" / 02.4 x 12.9 cm
折り畳まれたストロー: 3.54" / 9 cm
展開されたストロー: 8.27" / 21 cm

安全上の注意
充電ケーブルを充電中に使用しないでください
充電ケーブルを液体や油に濡らして使用しないでください
ストローケースに水や他の液体を入れないでください

中文
產品物
1. 可折疊式收納盒
1. 充電線
1. USB-C充電線

產品規格
1. 收納盒 (UV-可拆式)
2. 充電線 (充電線)
3. 主機
4. 充電線
5. USB-C充電線

規格及尺寸
收納盒尺寸: 00.94 x 5.08" / 02.4 x 12.9 cm
摺疊後吸管長度: 3.54"/9 cm
展開後吸管長度: 8.27"/21 cm

安全注意事項
充電時請勿使用充電線
請勿將充電線浸入液體或油類中
請勿將液體或油類放入吸管盒中

한국어
제품 구성
1. 접이식 UV 케이스
1. 충전 케이블
1. USB-C 충전 케이블

제품 사양
케이스 크기: 00.94 x 5.08" / 02.4 x 12.9 cm
접이식 빨대 길이: 3.54" / 9 cm
펼쳐진 빨대 길이: 8.27" / 21 cm

안전 주의 사항
충전 중에는 충전 케이블을 사용하지 않습니다
충전 케이블을 액체나 기름에 적시거나 사용하지 않습니다

안전 주의 사항
충전 중에는 충전 케이블을 사용하지 않습니다
충전 케이블을 액체나 기름에 적시거나 사용하지 않습니다

עברית
תכולת המוצר
1. כיסוי מתכווץ
1. כבל טעינה
1. כבל USB-C לטעינה

פרטים טכניים
מידות המוצר: 00.94 x 5.08" / 02.4 x 12.9 ס"מ
סליל סטרו מוכנס: 3.54" / 9 ס"מ
סליל סטרו מופקד: 8.27" / 21 ס"מ

אזהרות אבטחה
אל תשתמש בכבל הטעינה במהלך טעינה
אל תשתמש בכבל הטעינה בלחות או שמן
אל תשפוך נוזלים או שמן לתוך כיסוי הסטרו

אזהרות אבטחה
אל תשתמש בכבל הטעינה במהלך טעינה
אל תשתמש בכבל הטעינה בלחות או שמן
אל תשפוך נוזלים או שמן לתוך כיסוי הסטרו

العربية
محتويات المنتج
1. حقيبة قابلة للطي
1. كابل شحن
1. كابل USB-C للشحن

مواصفات المنتج
أبعاد العلبة: 00.94 x 5.08" / 02.4 x 12.9 سم
العلبة مغلقة: 3.54" / 9 سم
العلبة مفتوحة: 8.27" / 21 سم

تنبيهات الأمان
لا تستخدم الكابل أثناء الشحن
لا تستخدم الكابل في الأماكن الرطبة أو الملوثة بالزيت
لا تترك الكابل في الأماكن الحارة أو المباشرة بالشمس

تنبيهات الأمان
لا تستخدم الكابل أثناء الشحن
لا تستخدم الكابل في الأماكن الرطبة أو الملوثة بالزيت
لا تترك الكابل في الأماكن الحارة أو المباشرة بالشمس

POLSKI
W OPAKOWANIU
1x skrzynka wielofunkcyjna UV
1x kabel USB-C
1x instrukcja obsługi

INFORMACJE OGÓLNE
1. Typ produktu UV
2. Zastosowanie UV
3. Ciężar UV
4. Rozmiar UV
5. Materiał UV

Ważne ostrzeżenie
Nie używać urządzenia w mikrofalówce
Nie używać urządzenia w zmywarce
Nie używać urządzenia w wodzie

Ważne ostrzeżenie
Nie używać urządzenia w mikrofalówce
Nie używać urządzenia w zmywarce
Nie używać urządzenia w wodzie

TÜRK
KÜLTÜRÜN İÇİNDEKİLER
1x Yarıdan Kalınabilir ve Katlanabilir Pipet
1x Sanitizasyon Kutusu
1x Temizleme Fırçası

ÜRÜN TANIMI
1. Digne UV (UV-riutilizabil)
2. Kutu
3. Fırça
4. Pipet
5. Götürge pipeti

Önemli uyarılar
Sanitizasyon kutusunu, pipeti veya fırçayı hiçbir şekilde bulağına koymayın
Mümkün olduğunda pipeti ve fırçayı suyla yıkayın

Önemli uyarılar
Sanitizasyon kutusunu, pipeti veya fırçayı hiçbir şekilde bulağına koymayın
Mümkün olduğunda pipeti ve fırçayı suyla yıkayın

ไทย
ผลิตภัณฑ์ประกอบด้วย
กล่องที่ใช้งานได้หลายฟังก์ชัน 1 ชิ้น
กล่องใส่หลอด 1 ชิ้น
แปรงทำความสะอาด 1 ชิ้น
หลอดดูดน้ำ 1 ชิ้น
แปรงทำความสะอาด 1 ชิ้น

คำเตือนที่สำคัญ
อย่าใส่กล่องใส่หลอดในตู้ล้างจาน
อย่าใส่กล่องใส่หลอดในไมโครเวฟ
อย่าใส่กล่องใส่หลอดในน้ำร้อน

คำเตือนที่สำคัญ
อย่าใส่กล่องใส่หลอดในตู้ล้างจาน
อย่าใส่กล่องใส่หลอดในไมโครเวฟ
อย่าใส่กล่องใส่หลอดในน้ำร้อน

คำเตือนที่สำคัญ
อย่าใส่กล่องใส่หลอดในตู้ล้างจาน
อย่าใส่กล่องใส่หลอดในไมโครเวฟ
อย่าใส่กล่องใส่หลอดในน้ำร้อน

EUROPEAN UNION CE
LEXON hereby declares that the device is in compliance with the essential requirements and other relevant provisions of directives 2014/53/EU (RED), 2011/65/EU (RoHS) and 2014/30/EU (EMC). The original EU declaration of conformity may be found at: https://www.lexon-design.com/assets/certificates/red-romadnay-uv-straw.pdf

UK conformity assessment
The device described above is in conformity with the relevant UK harmonisation legislation. This equipment conforms to the CE mark as may be found at: https://www.lexon-design.com/assets/certificates/uk-ca-nomaday-uvstraw.pdf

DISPOSAL AND RECYCLING INFORMATION
This device complies with Part 15 of the FCC Rules. Operation is restricted to the power level authorized in the FCC Rules. This device may cause interference, and you are encouraged to protect the interference by one or more of the following measures:

IC warning
This device contains license-exempt transmitter(s)/receiver(s) that comply with Innovation, Science and Economic Development Act of Canada and its associated regulations. The equipment should be installed and operated with minimum distance of 20cm between the radiator and your body.

LEXON hereby declares that the device is in compliance with the essential requirements and other relevant provisions of directives 2014/53/EU (RED), 2011/65/EU (RoHS) and 2014/30/EU (EMC). The original EU declaration of conformity may be found at: https://www.lexon-design.com/assets/certificates/red-romadnay-uv-straw.pdf

UK conformity assessment
The device described above is in conformity with the relevant UK harmonisation legislation. This equipment conforms to the CE mark as may be found at: https://www.lexon-design.com/assets/certificates/uk-ca-nomaday-uvstraw.pdf

DISPOSAL AND RECYCLING INFORMATION
This device complies with Part 15 of the FCC Rules. Operation is restricted to the power level authorized in the FCC Rules. This device may cause interference, and you are encouraged to protect the interference by one or more of the following measures:

IC warning
This device contains license-exempt transmitter(s)/receiver(s) that comply with Innovation, Science and Economic Development Act of Canada and its associated regulations. The equipment should be installed and operated with minimum distance of 20cm between the radiator and your body.

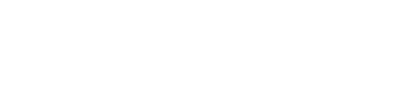

125, Avenue des Champénois - 75008 Paris - FRANCE
www.lexon-design.com